

4-H Dog Junior Showmanship Manual



THE JUNIOR HANDLER

Appearance

Remember that you never get a second chance to make a first impression. Your appearance is important to the impression you make in the ring. Be neat, attractive, comfortable and pleasant to watch. Girls should wear skirts, culottes or dresses that are below the knee. Attractive pants are also acceptable in some shows. Avoid wearing jewelry that makes noise or interferes with handling. Boys should wear a suit or sports slacks and a jacket, with a shirt and tie or turtleneck; a sweater is also acceptable. Wear your hair away from your face to avoid distraction from your expression and to help you see clearly.

Low-heeled, rubber-soled shoes are best since they provide good traction and are quiet when you gait your dog. Neat and clean tennis shoes or other canvas shoes are also acceptable.

All clothing should be appropriate for moving when handling a dog. Choose attire that allows free movement of your arms and legs. The color of your clothing should contrast with your dog without distracting from it. If your dog is one color, you can wear a solid color that allows your dog to look good and stand out, or you can wear a quiet print that contains the color of your dog. If your dog is varied in color or pattern, wear a solid color that matches one of your dog's colors. Your dog's show lead should match the color of its neck.

Above all, be neat and clean. Try to keep your clothing free of dog hair.

Posture

During showing, check your posture and position constantly. Stay

at least an arm's length from your dog, keeping plenty of space between you and the dog so you don't block the judge's view. When lowering yourself to your dog's level and rising again, try to keep your body straight and use your legs to raise and lower yourself. Kneeling may be appropriate for some breeds for posing only. When showing large breeds, bend at the waist only when necessary and as quickly and smoothly as possible.

Smoothness

Be calm, don't rush, and try to appear relaxed and in command of the situation. Appear cool and collected, but don't hold up the judging procedure. Conserve your movements by being methodical. Know what to do and do it without fussing. Make each action smooth and controlled. Jumpy and jerky actions make a handler look nervous and unsure, and may upset the dog.

Animation

Look confident, alive and active! Don't appear bored. Smile and enjoy what you're doing, and make the experience enjoyable for your dog as well.

Attention

Watch your dog, the judge and the other handlers. Pay attention to where you are stepping, gaiting, standing and looking. Know where the judge is and always keep your dog between the judge and you. Use some eye contact with the judge, but don't ignore your dog. Recognize what the judge is doing and try to detect what he or she is looking for. Help the judge by listening and following directions exactly.

Proficiency

Make sure you know and follow the rules. Groom your dog perfectly and pose it properly. Know exactly what to do during each aspect of the competition (such as individual examination of your dog and gaiting). If your dog is small, be prepared to present it on a table. If you need to remove the lead, place it behind you to your right (if you are right-handed), being careful to place it so you can retrieve it and put it on your dog quickly and without effort. Gait your dog correctly. Hold the lead properly, keeping the excess lead gathered in your hand. Know exactly where you as a handler should stand and be there. Polish your performance to perfection!

Ring Courtesy

Never do anything that may distract other dogs or handlers. Don't make sudden movements or noises. Don't talk to other handlers or spectators. Avoid speaking constantly or loudly to your dog. Talk to your dog only

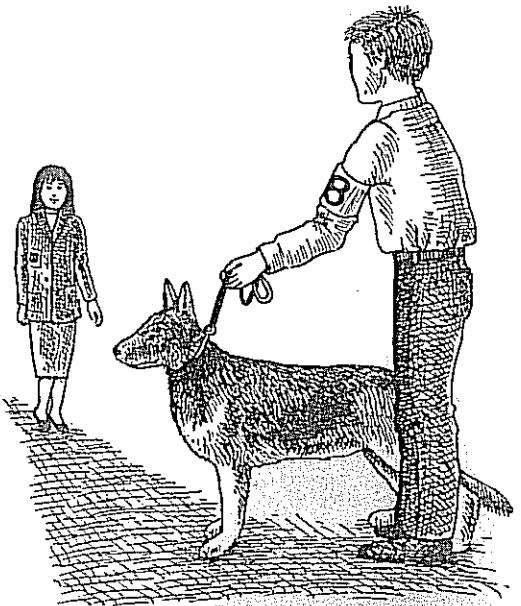

to excite or calm it. Don't crowd the handler and the dog ahead of you when in line or during group gaiting. Space yourself about three feet from the dog in front of you. If you bait your dog, keep the bait off the ground or floor. Retrieve any bait that falls. Never upstage another handler. Never take your dog completely out of line or off the mat unless told to do so by the judge or by the steward. Keep in mind that it's a poor handler who resorts to making others look bad to make himself or herself look good.

Attitude

Go into the ring to do the best job you are capable of doing. Always be a good sport. Whether you win or lose, be humble and gracious. Congratulate the winners and be

sincere. In a like fashion, if you are fortunate enough to win a class or show, accept congratulations from others humbly and sincerely.

If the judge makes comments about your handling, listen and thank him or her. Tell your instructor or leader what the judge said and work on it. Remember, good sportsmanship is the most important element you can display in the ring. Enjoy doing the best you can, regardless of whether you win.

After returning home from the show, be sure to express your appreciation with a thank you note or letter to the people who helped in some way. Some of the people to include are:

- Show management officials
- Superintendent(s)
- 4-H staff and volunteers
- Donators of trophies and awards

Effort

Effort is the most important and the hardest point to display in dog junior showmanship. Always keep trying and never give up! You can continue to do your best job of handling even when your dog is uncooperative. If your dog is well-trained to the point that it appears "steady as a rock," reposition it occasionally. When the dog does it all, leaving nothing for the handler to do, competing is no longer a challenge. You must appear to be working, but as calmly and as effortlessly as possible. If you end up on the losing end of the line, remember that it is you, not your dog, who has been judged. Your placement is not your dog's fault.



THE DOG

Grooming

Grooming is important to the presentation of your dog, and junior handlers are responsible for grooming their own dogs. Groom your dog meticulously ahead of show time. The dog's nails should be trimmed, and its coat, ears, eyes and teeth should be clean. Pet or show clips are equally acceptable in dog junior showmanship.

Proper Presentation of the Breed

With your dog standing, use the proper posing method (also referred to as "stacking") for your particular dog, whether it's a pure breed or mixed breed. Know the proper positioning of your dog's head and tail. If needed or customary for the breed, bait your dog so it will exhibit the proper expression. Breeds that are the size of a Shetland sheepdog or smaller should be

presented for examination on a table if one is available. The correct place to set up a dog is the upper left corner (closest to the judge) or as close as you can get to that position.

Baiting

Most dogs enjoy being baited, and if done properly, baiting can put the finishing touch on your performance. If you have a breed that needs to be baited (such as a Doberman pinscher, collie or Shetland sheepdog), you can use any bait your dog likes. Some commonly used baits are soft-baked liver, hot dogs and cat treats.

When baiting, stand in front of your dog. If the judge is on the left side of your dog, hold the bait in your right hand and the show lead in your left hand (reverse if the judge switches sides). Use the bait to keep your dog attentive and animated. Don't distract the judge by waving your arm around while baiting.

Instead, keep your arm fairly still and be subtle. Don't let your dog eat the bait when the judge is looking at your dog. Do let your dog eat a **little** bit to keep its interest when the judge is not looking.

Baiting should be done whenever your dog is posed. When gaiting your dog, most breeds should be baited as soon as they are stopped in front of the judge. Do not hold bait in front of your dog while gaiting.

Knowledge of Your Dog

Be knowledgeable about your dog's breed. Know how it deviates from the breed standard and be able to correct for these faults when showing. Be aware of your dog's good points. It's helpful to know the dog's anatomy as well (see figure 1). For example, if a judge were to say, "Your dog's hock should be perpendicular to the floor," you should know what part to correct.

Figure 1. Anatomy of the dog.

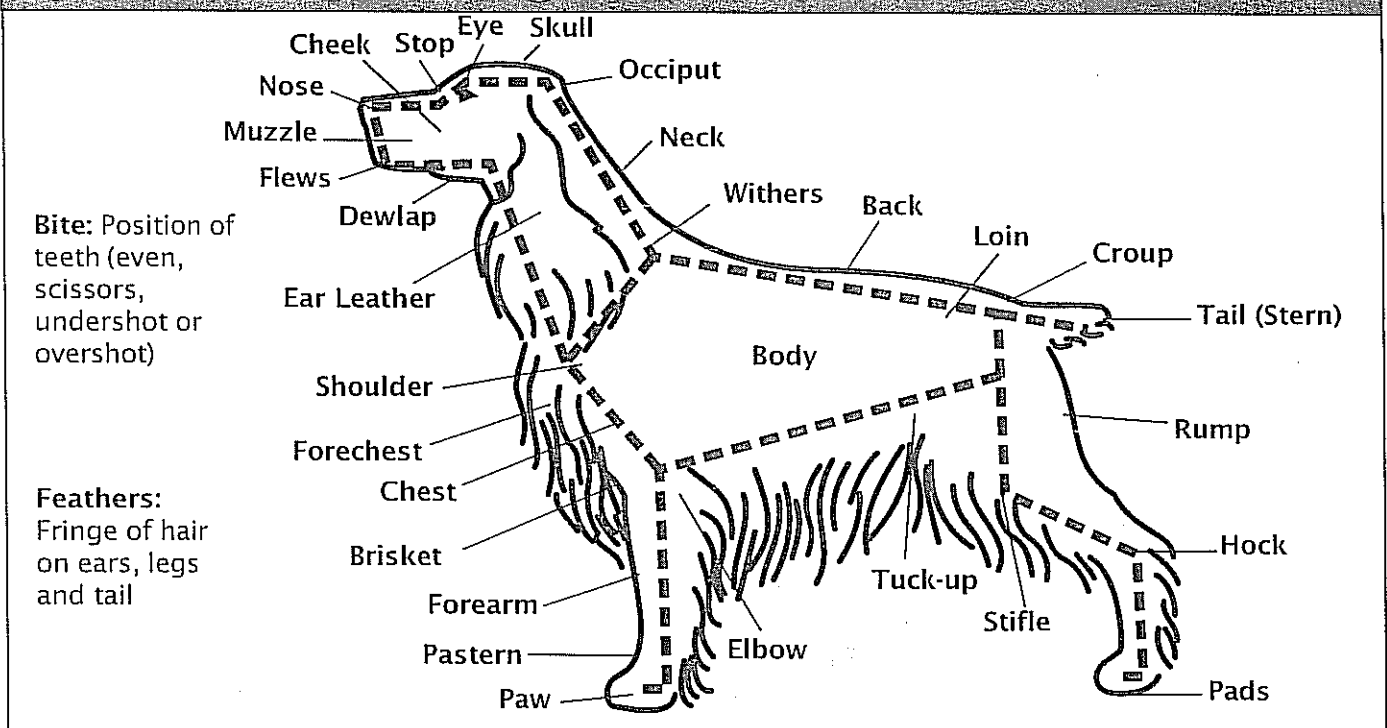

THE JUNIOR SHOWMANSHIP TEAM

Compatibility With Your Dog

Work as a team in the ring. Use your hands to command and reassure your dog. Do not use your feet to position or control your dog. Be kind and **never**, under any circumstances, reprimand your dog physically for disobeying you.

Use mirrors to become aware of how you look with your dog in posing and gaiting. Study photographs or videotapes of you and your dog in action.

Preparedness (Alertness)

Be ready for whatever the judge wants you to do. Watch the exhibitors ahead of you and be prepared and in position for the individual examination and gaiting (for example, keep the lead gathered and in the proper position). Don't hold up the judging procedure. Anticipate how your dog will react and be ready for it. Learn what the judge will be looking for and make sure he or she sees it!

Posing or Stacking the Dog

Stand your dog on the inside edge of the mat (or in line if no mats are used). If you're at a corner, "round" the circle, using both mats that form the corner. Be sure you keep lots of space between you and the dog in the front of you, so you aren't crowded and can be seen. The judge can't see you if you're hidden in a corner. When posing your dog, stay at least an arm's length from it. This gives you plenty of room to move smoothly around your dog and keep it between you and the judge at all times. Don't set your dog in a position odd to the others. Posing views are shown in figures 2, 3 and 4.

Figure 2. Posing your dog (side view).

Several things are done the same with all breeds:

- A. The head is kept above the level of the back.
- B. The front leg is placed perpendicular to the floor by picking it up by the elbow. Place the front leg closest to the judge first, then the other front leg.

- C. The hocks are also perpendicular to the floor, placing the leg closest to the judge first. The only exception is for German shepherds.

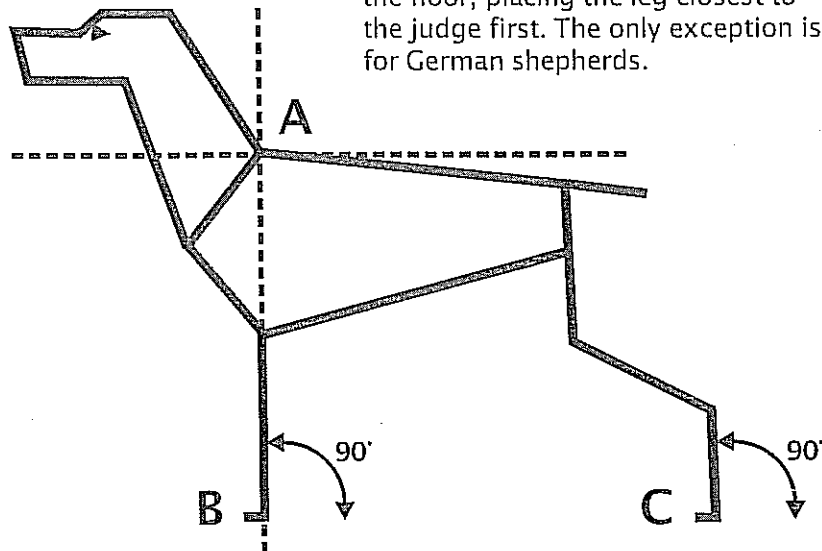
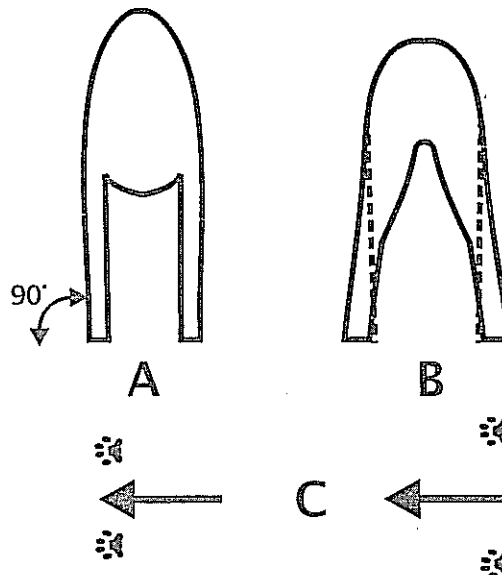

Figure 3. Posing your dog (front view [A], rear view [B] and feet [C]).



- A. The front legs are perpendicular as viewed from the front. The width at the shoulder is the same as the width at the floor.

- B. The width at the hip is the same as the spread between the rear feet.

- C. All four feet should point forward.

Gaiting

Always keep your show lead in the hand that is beside the dog. Make your gaiting smooth, straight and the correct speed. Keep your dog trotting, not galloping, pacing or shuffling along. (Trotting is when one front leg and the opposite rear leg move forward at the same time. Pacing is when the legs on the same side of the dog move forward at the same time.)

When in motion, your dog should move naturally and freely, just far enough ahead of you that you must extend your arm slightly. Avoid traveling ahead of your dog. If your dog is unwilling to move out in front of you, stay at or slightly behind its shoulder area.

Do not keep the lead too tight or too loose for your breed or individual dog. Know every gaiting pattern and be able to reverse your direction.

To keep the dog in the judge's view, make changing the lead from one hand to the other a smooth,

Figure 4. German Shepherd posing.

If your dog is a German shepherd, the head poses up and forward with a loose lead. Ears should be erect, and the pasterns are not perpendicular to the floor. The rear leg farthest from the judge is placed under the body and the tail drapes between the rear legs. The handler should stand at or near the dog's head.

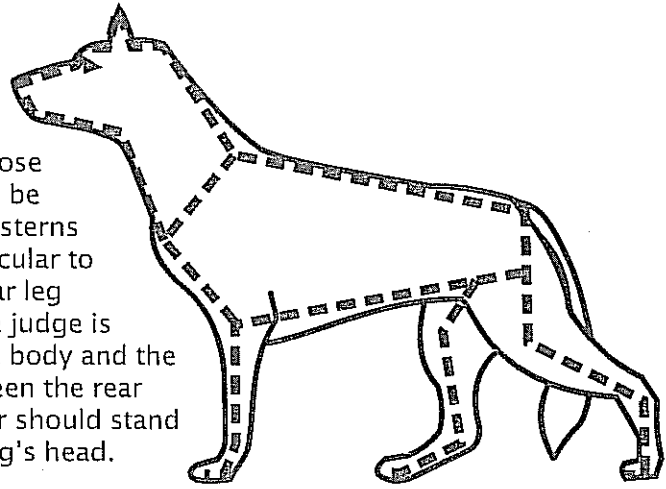

continuous action. Keep your back straight, your head up and watch where you're going. Keep an eye on the judge and an eye on your dog. Run silently; avoid unnecessary motions or noises that detract from the gaiting procedure. Show poise, grace and animation. Use the entire ring unless the judge tells you to do otherwise. The mat is for the dog to run down the center on without slipping. If you are wearing the proper footwear (see "Appearance"

on page 3), you won't have to crowd the dog for the mat. Bait should not be used while the dog is in motion.

The Team in Action

Figures 5 to 15 on the following pages illustrate the various types of gaiting and posing you'll be asked to do during a dog junior showmanship contest. In all these figures, "D" represents the dog and "H" represents the handler.

Figure 5. Gaiting in a group with the judge in the center.

Leave space between dogs. Only bypass dogs that refuse to move. Be considerate of dogs that have slowed or stopped.

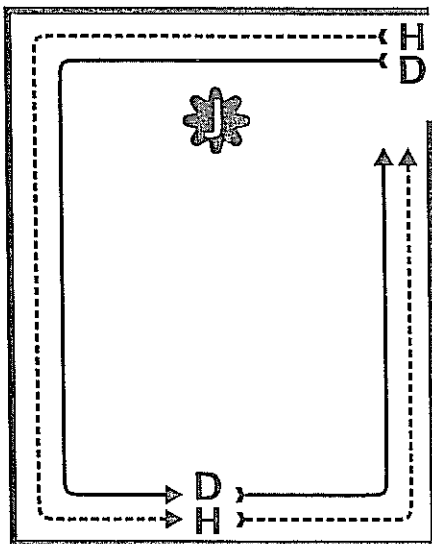

Figure 6. Gaiting in a group with the judge in the corner.

Cross behind the dog as you approach the judge. Cross in front of the dog after you pass the judge.

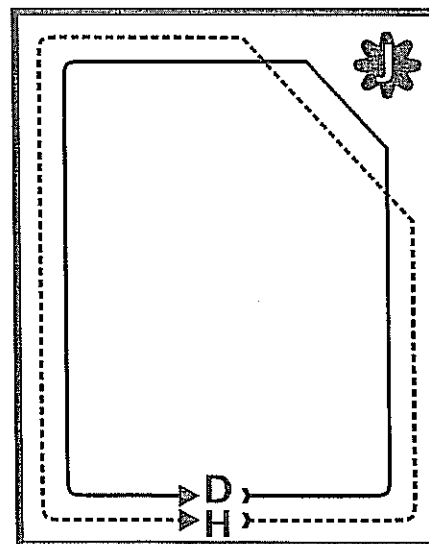

Figure 7. Gaiting in a group with the judge at the side or in a corner.

Cross behind the dog at the corner before the judge. Cross in front of the dog at the corner after the judge.

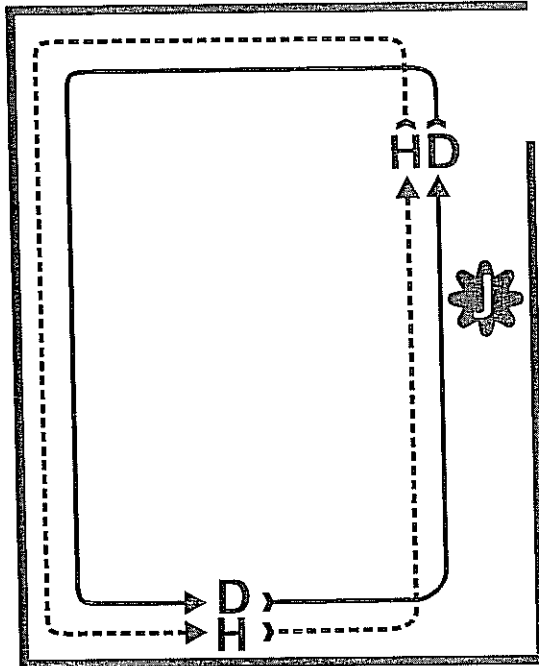

Figure 8. Gaiting the left corner "L."

Make a smooth left turn. Change dog to the right side at the end. Cross behind dog to put dog on left when returning to the judge. At the corner, make a small circle to the right so the dog is gaiting straight toward the judge.

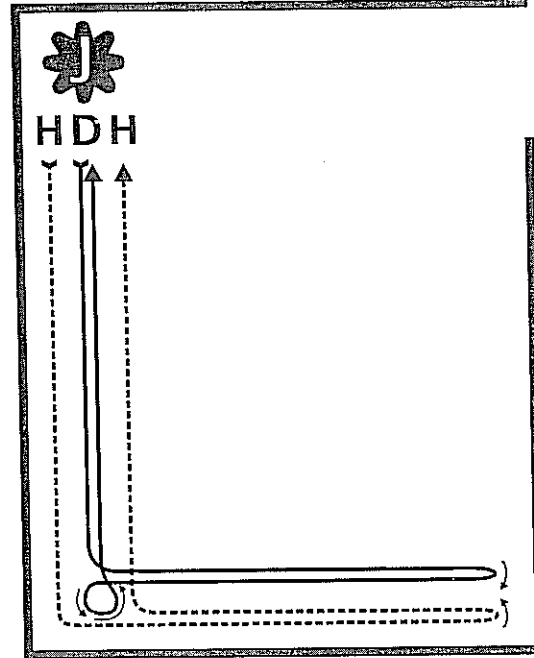

Figure 9. Gaiting straight out and back with about-turns.

Be sure the dog is gaited away from and to the judge in a straight line. The dog should not stop moving in the about-turn. Pattern A is nice for small or slow-moving dogs. Patterns B, C and D are for large or fast-moving dogs, or when it is necessary to change sides.

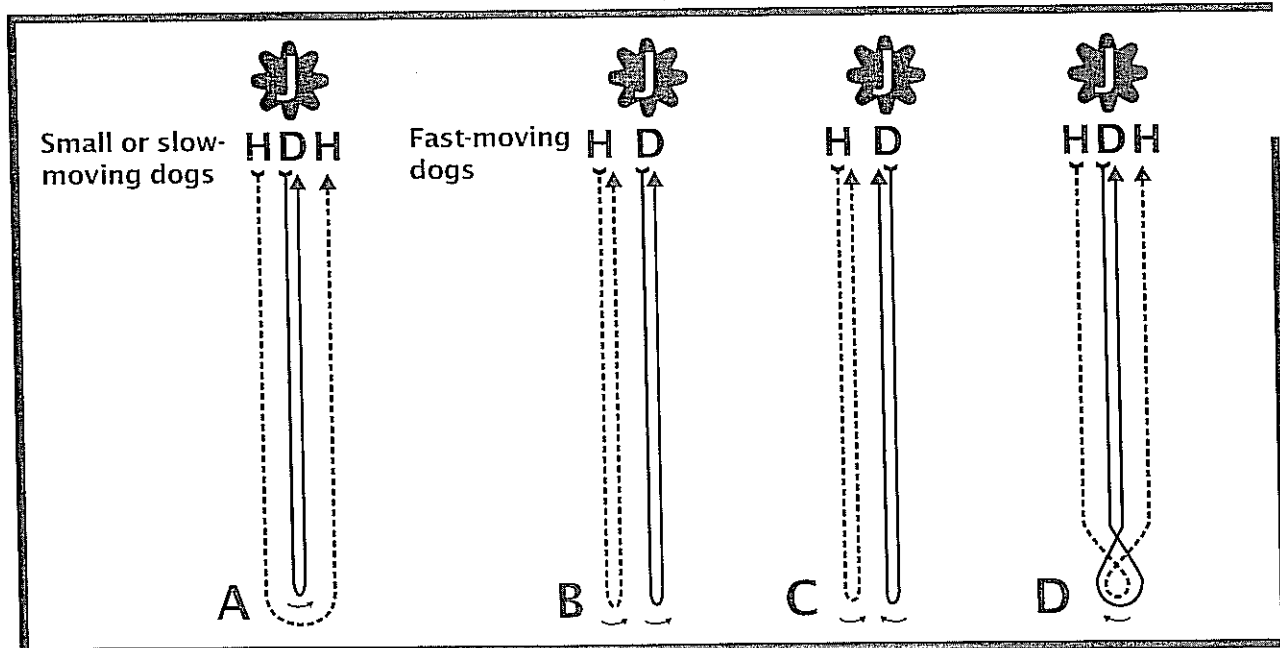

Figure 10. Gaiting the right corner "L."

Cross in front of dog at the turn. At the end, change dog to left side. Complete smooth left turn.

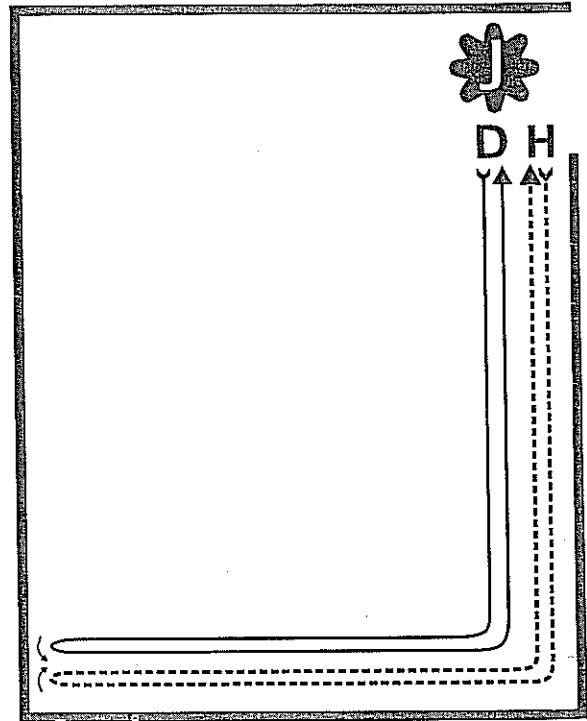
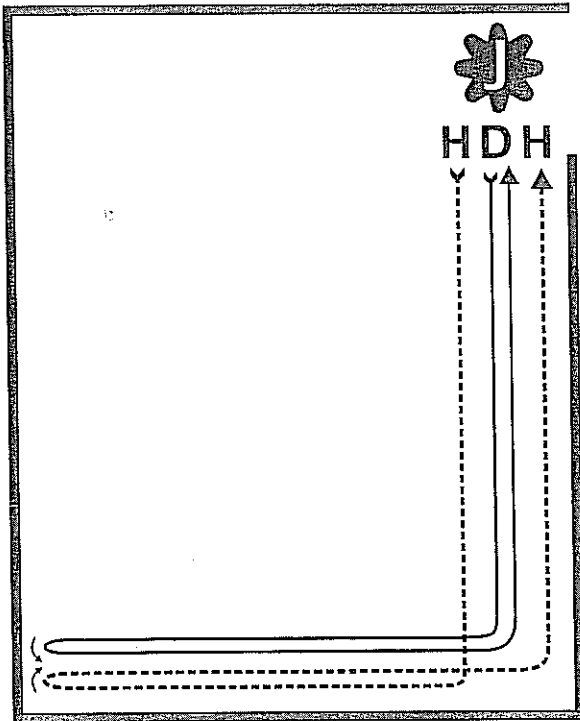

Figure 11. Gaiting the triangle: left turn. Smooth corners.

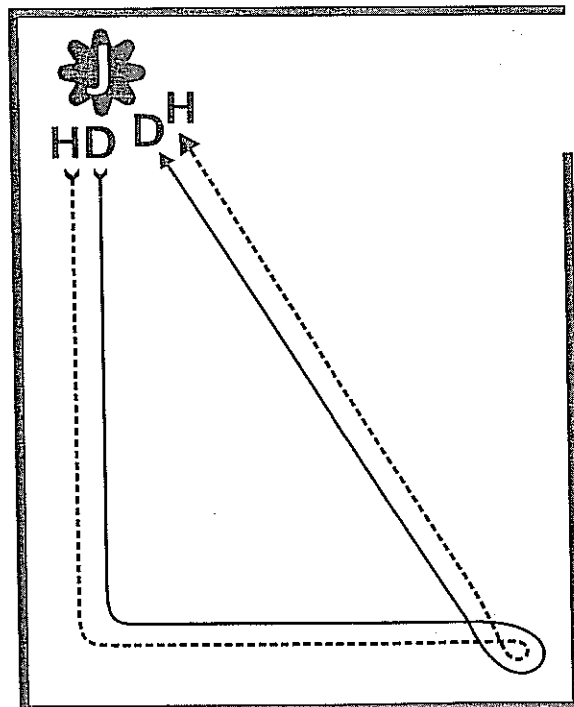
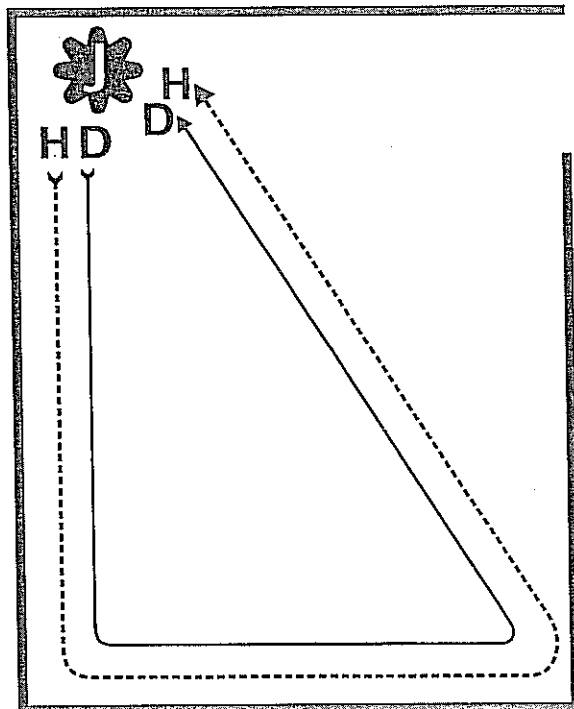

Figure 12. Gaiting the "T."

Straight away and turn left. About turn, changing hands to put dog on right. Gait to the other end of the ring. About turn, changing hands to put dog on left. Left turn, return to judge. Large or fast-moving dogs should do a right circle before they return to the judge.

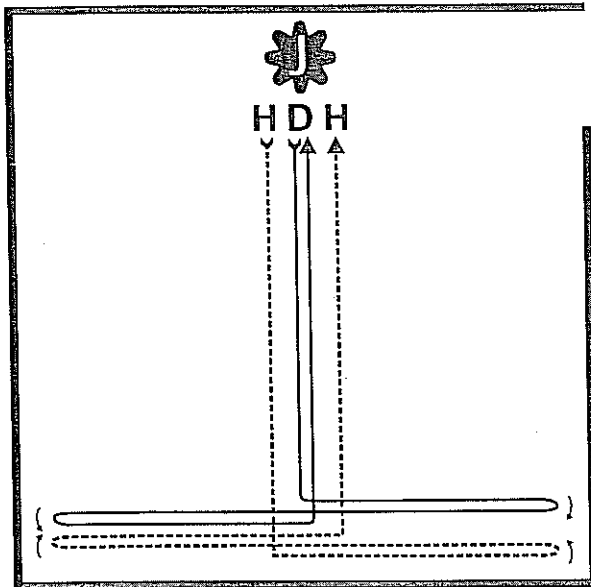

Figure 13. Gaiting dogs in pairs.

Dogs stay in the middle. Wait until the other handler is ready. Keep the dogs together. Wait for the slower dog.

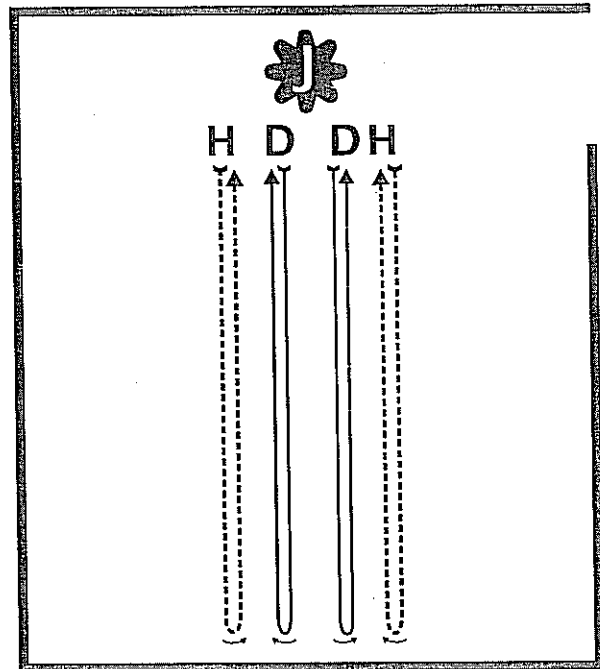

Figure 14. Front stop.

Stop the dog about 3 to 4 feet from the judge. Stop the dog on a slight angle, with the handler completely in the front (A) or slightly to the front (B). Allow a natural stop (don't set the dog up). Stand with the dog. If the judge moves around your dog, move around the dog to keep the dog between the judge and you.

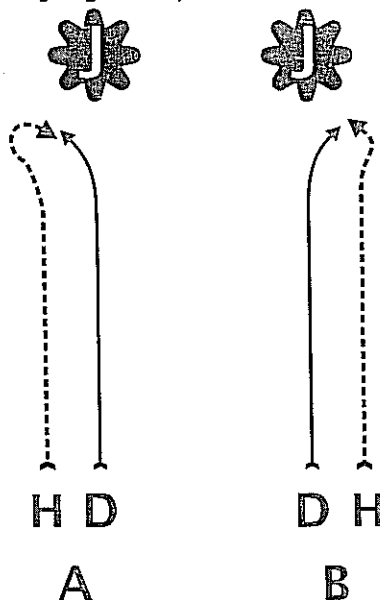

Figure 15. Corners

- A. Smooth corner; handler and dog turn together.
- B. Handler changes sides by stepping in front of dog, passing lead behind back (good for small dogs).
- C. Handler changes sides by crossing behind dog (as dog circles) (good for large or fast dogs).
- D. Handler changes sides by crossing behind dog (good for small or slow dogs).

